

Woordbeeldkaart vierletterwoorden

s-t-o-e-l

stoel

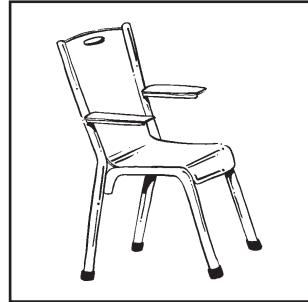

j-u-r-k

jurk



t-r-a-p

trap



k-r-i-j-t

krijt

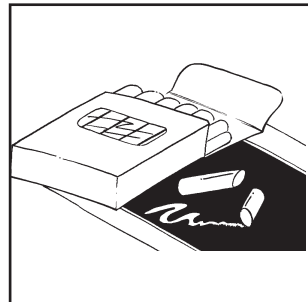

h-e-r-t

hert

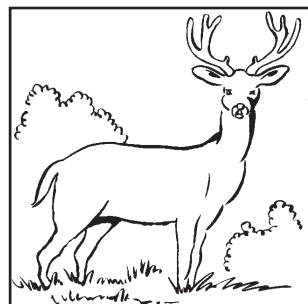

Woordbeeldkaart vierletterwoorden

t-r-ei-n

trein

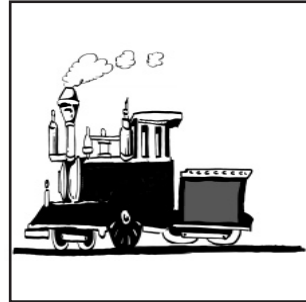

b-r-u-g

brug

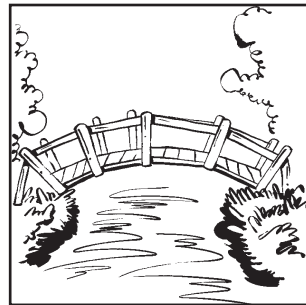

z-w-a-a-n

zwaan

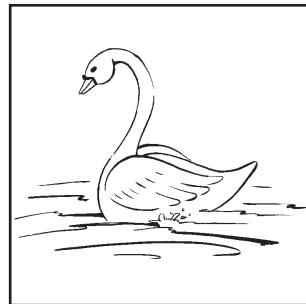

t-a-a-r-t

taart



f-ie-t-s

fiets

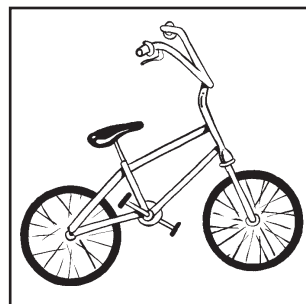

Woordbeeldkaart vierletterwoorden

f-l-e-s

fles

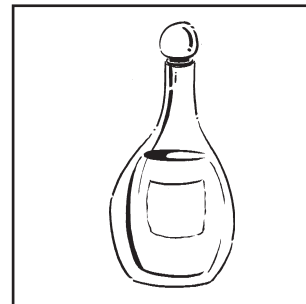

s-p-i-n

spin

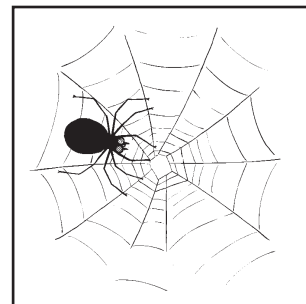

k-oe-t-s

koets

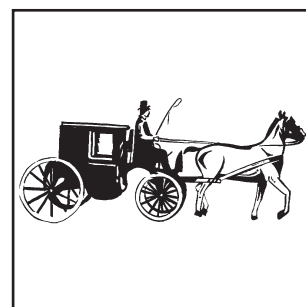

t-u-l-p

tulp

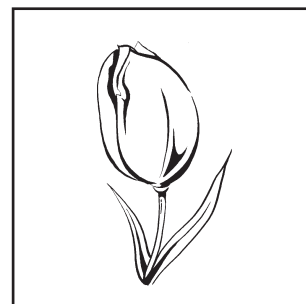

s-t-ou-t

stout



Woordbeeldkaart vierletterwoorden

f-l-ui-t

fluit

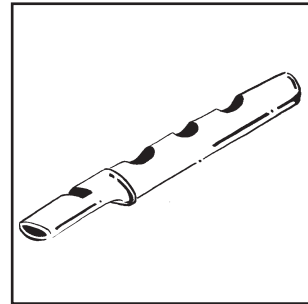

g-l-a-s

glas

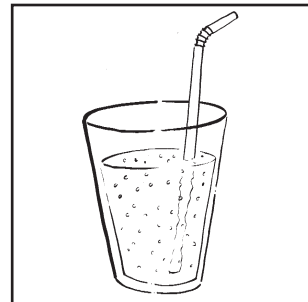

h-a-r-k

hark

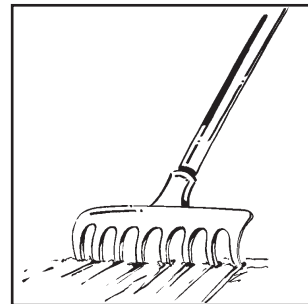

b-r-ie-f

brief

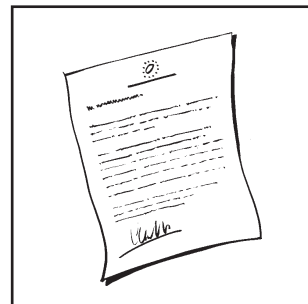

s-n-o-r

snor



Woordbeeldkaart vierletterwoorden

v-l-e-k

vlek

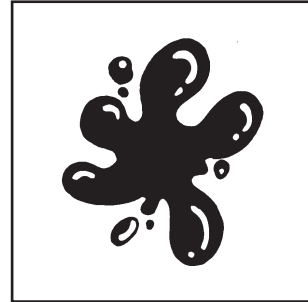

b-e-r-g

berg

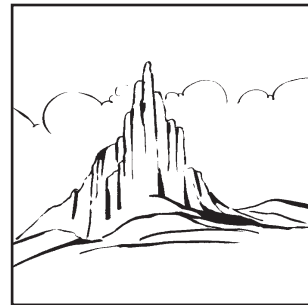

k-r-a-a-g

kraag

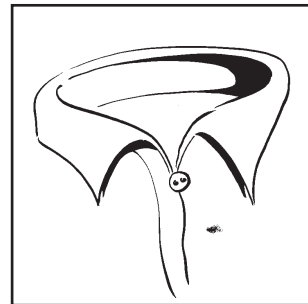

v-u-i-st

vuist

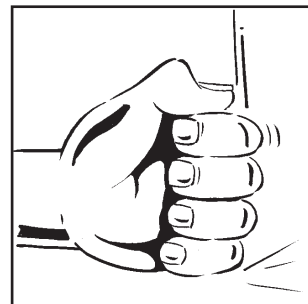

k-l-e-i-n

klein

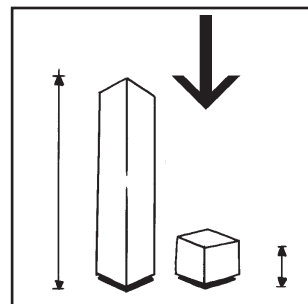

Woordbeeldkaart vierletterwoorden

k-i-s-t

kist

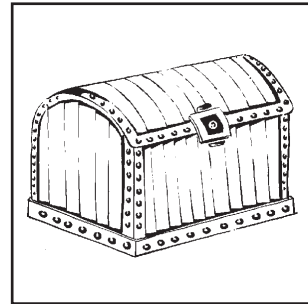

k-a-a-r-t

kaart

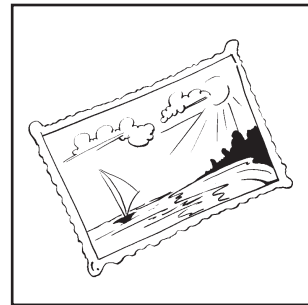

m-e-l-k

melk



h-e-l-m

helm

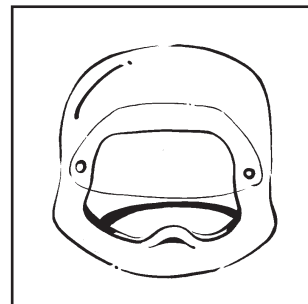

d-a-n-s

dans



Woordbeeldkaart vierletterwoorden

v-e-r-f

verf

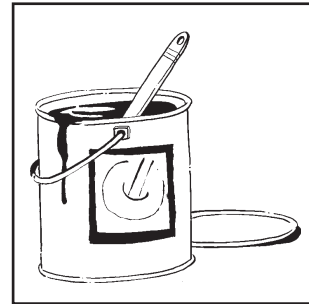

g-a-n-s

gans

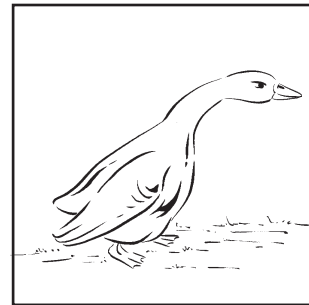

l-a-m-p

lamp

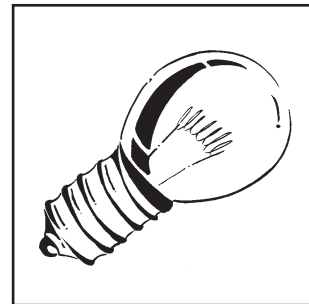

k-a-a-r-s

kaars

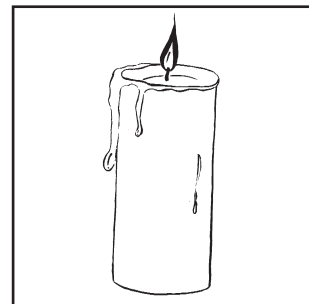

l-o-n-t

lont

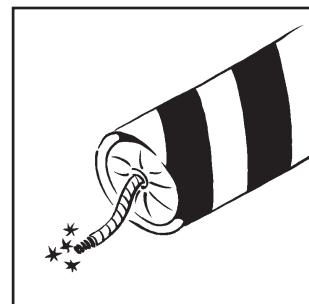

Woordbeeldkaart vierletterwoorden

w-o-r-m

worm

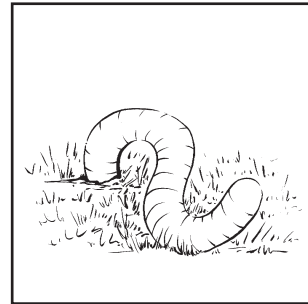

g-o-l-f

golf



b-r-oe-k

broek

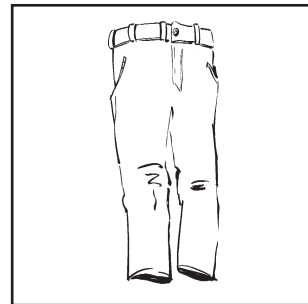

w-o-l-k

wolk

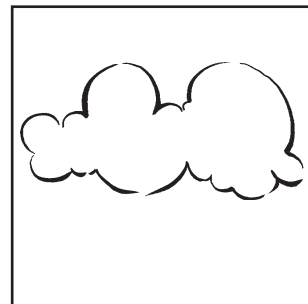

s-t-uu-r

stuur

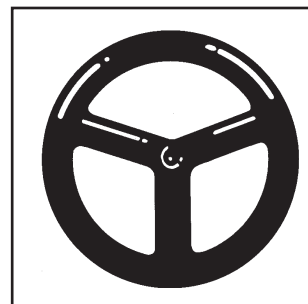

Woordbeeldkaart vierletterwoorden

k-i-s-t

kist

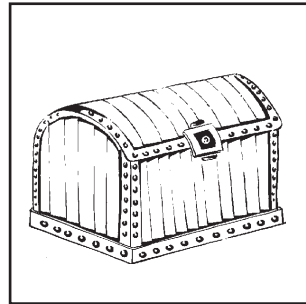

p-l-ui-m

pluim

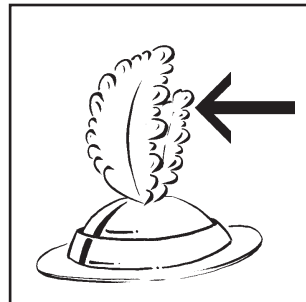

s-t-oe-p

stoep

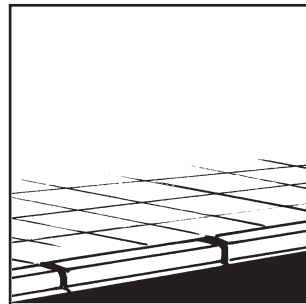

t-r-ei-n

trein

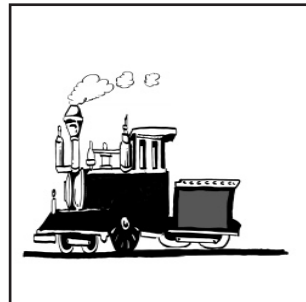

v-r-OU-W

VROUW

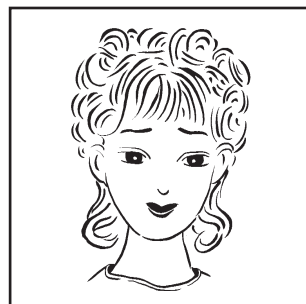

Woordbeeldkaart vierletterwoorden

v-l-ie-g

vlieg

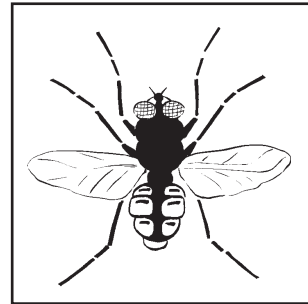

p-r-i-k

prik

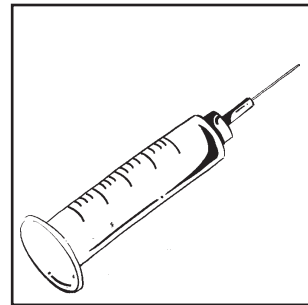

z-w-a-a-n

zwaan

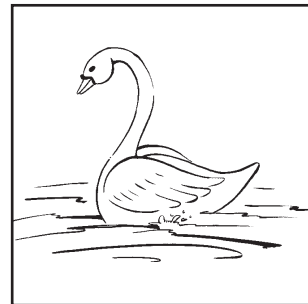

b-l-oe-m

bloem

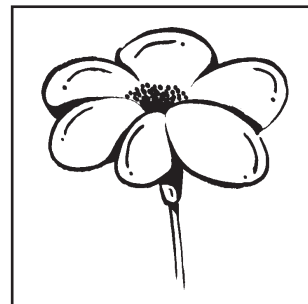

f-r-ui-t

fruit

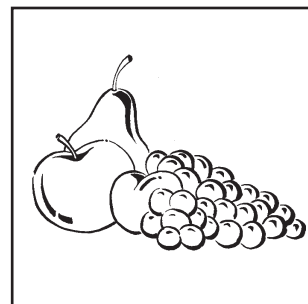

Woordbeeldkaart vierletterwoorden

g-r-a-a-t

graat

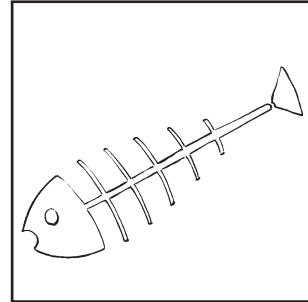

k-l-o-s

klos

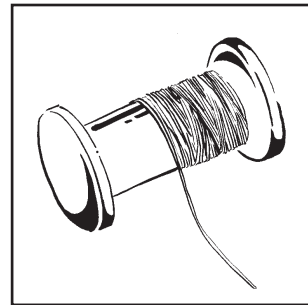

k-r-o-o-n

kroon

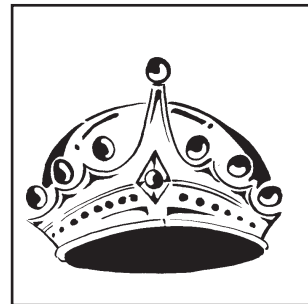

b-r-o-e-k

broek

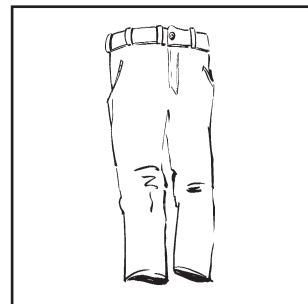

f-l-u-i-t

fluit

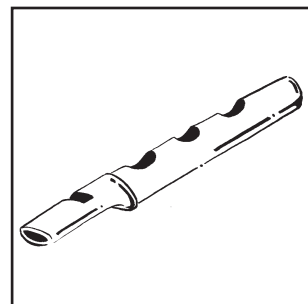

Woordbeeldkaart vierletterwoorden

k-r-ui-s

kruis

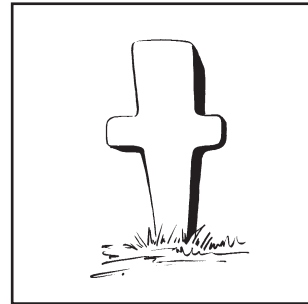

p-r-i-k

prik

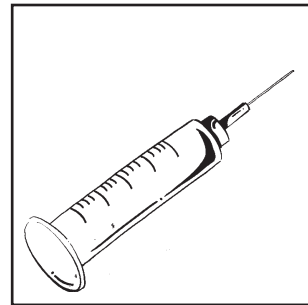

s-l-a-k

slak

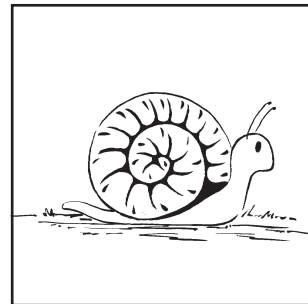

s-p-ee-r

speer

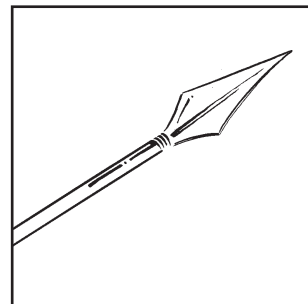

p-l-ui-m

pluim

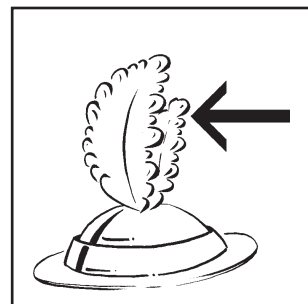

Woordbeeldkaart vierletterwoorden

j-u-r-k

jurk

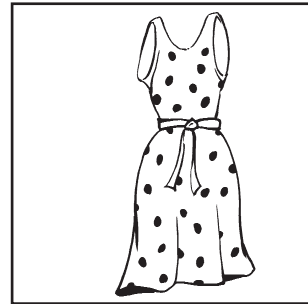

h-a-l-s

hals

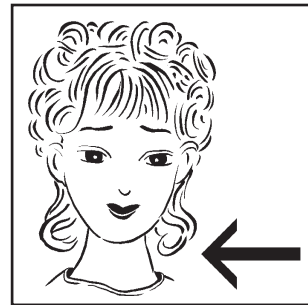

h-e-k-s

heks



p-u-n-t

punt

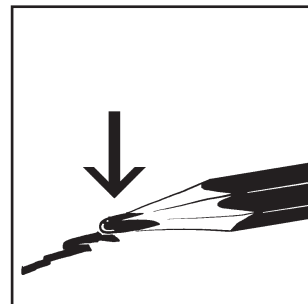

t-a-a-r-t

taart



Woordbeeldkaart vierletterwoorden

d-o-l-k

dolk

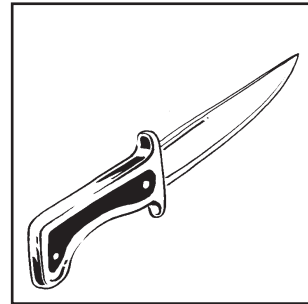

m-a-s-t

mast

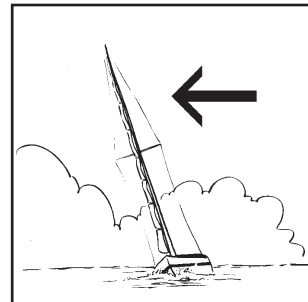

t-u-l-p

tulp



n-e-s-t

nest

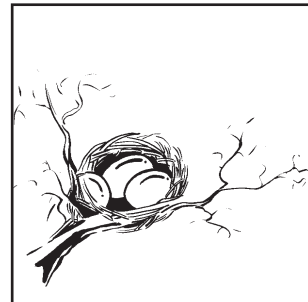

t-e-n-t

tent

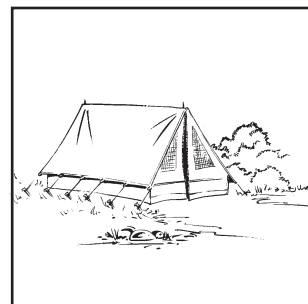

Woordbeeldkaart vierletterwoorden

b-u-l-t

bult



m-u-t-s

muts

